

Beschreibung Dralldurchlässe mit verstellbaren Lamellen.

Material Stahlblech.

Oberfläche Gefärbt in RAL 9010 oder wahlweise.
Lamellen: schwarz oder weiss.

Montage Mit Schrauben (zentrale Befestigung).

Zusätze K: Anschlusskasten (siehe Seite 34 und 36)

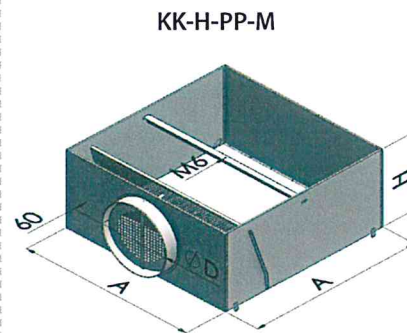

KK-H-PP-M

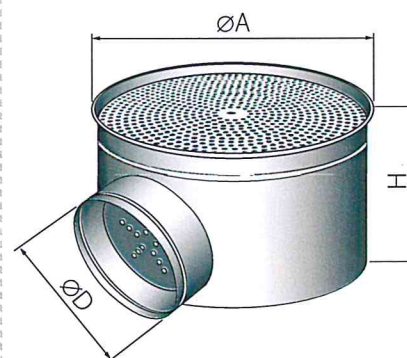

KO-H-PP-M

DVO-Q

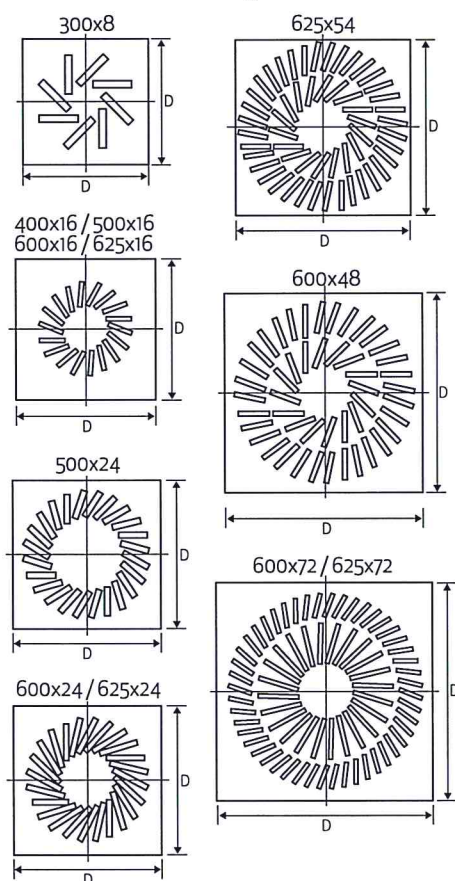

DVO-R

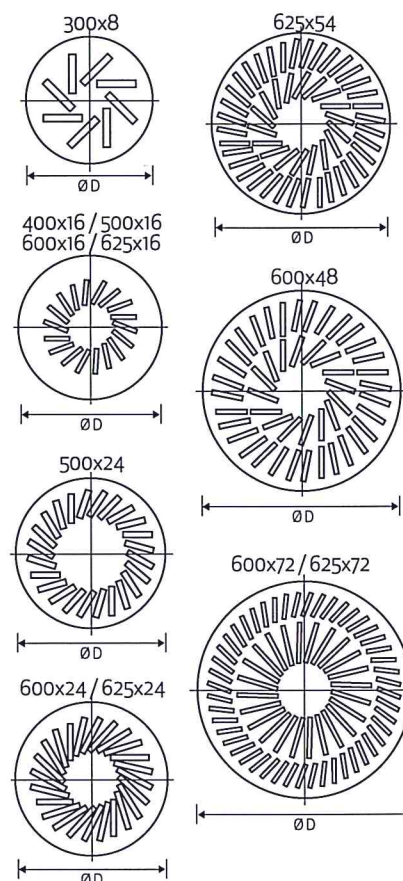

Grossen [mm]	$\varnothing D$	D	V_{max} [m³/h]	$A_{ef} - R$ [m²]
300 x 8	300	295	160	0,009464
400 x 16	400	395	360	0,018928
500 x 16	500	495	360	0,018928
600 x 16	600	595	360	0,018928
625 x 16	625	620	460	0,018928
500 x 24	500	495	430	0,028392
600 x 24	600	595	680	0,044928
625 x 24	625	620	680	0,044928
600 x 48	600	595	880	0,056784
625 x 54	625	620	960	0,063882
800 x 72	800	795	1200	0,101712
825 x 72	825	820	1200	0,101712

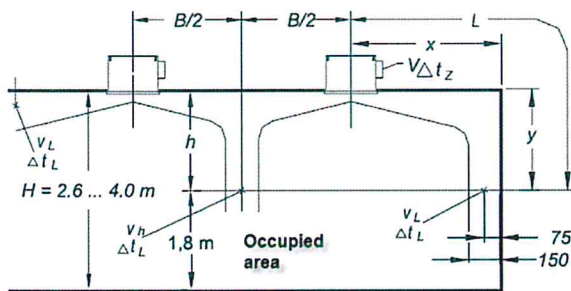

Beschreibung

- V [m³/h] - Volumenstrom
- y [m] - vertikale Entfernung
- x [m] - horizontale Wandentfernung
- A, B [m] - Abstand zwischen Luftdurchlässen
- C, X [m] - Abstand zwischen Wand und Luftdurchlasse
- L [m] - Reichweite
- V_L [m/s] - Luftgeschwindigkeit an Reichweite L
- h [m] - Abstand zwischen Decke und Aufenhaltzone
- V_h [m/s] - Luftgeschwindigkeit an Entfernung h
- t_z [°C] - Zulufttemperatur
- t_p [°C] - Raumtemperatur
- t_m [°C] - Strahltemperatur
- Δt_z [K] - Temperaturdifferenz zwischen Raumluft und Zuluft
- Δt_L [K] - Differenz zwischen Raumluft und Strahltemperatur
- Δp_s [Pa] - Gesamtdruckverlust
- LWA [dB(A)] - Schalleistungspegel

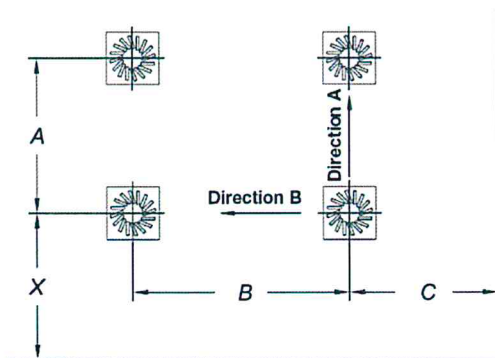

A. Luftgeschwindigkeiten und Temperaturquotienten $\Delta t_L / \Delta t_z$

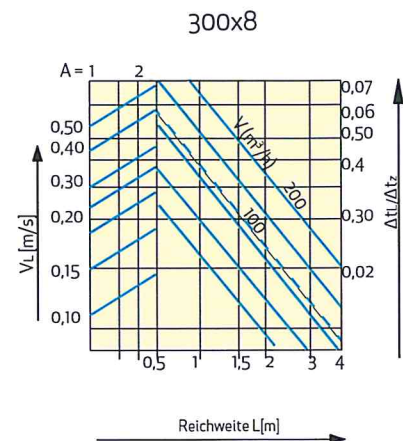
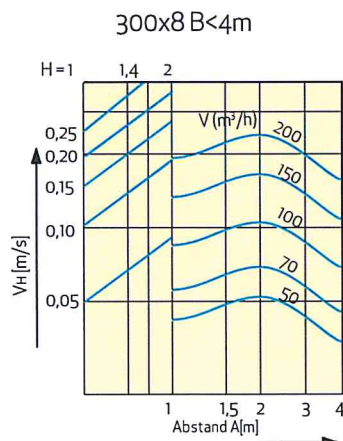
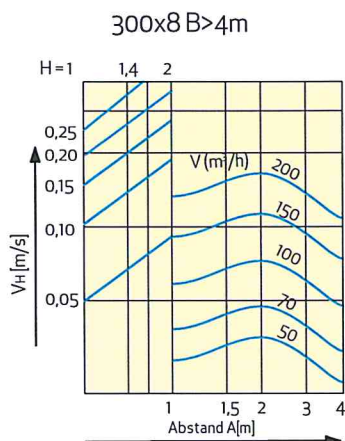

Änderungen vorbehalten

400x16, 500x16, 600x16, 625x16 B>4m

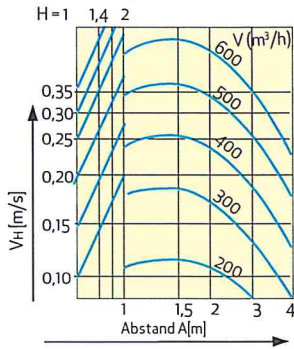

400x16, 500x16, 600x16, 625x16 B<4m

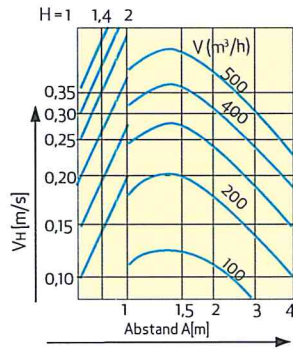

400x16, 500x16, 600x16, 625x16

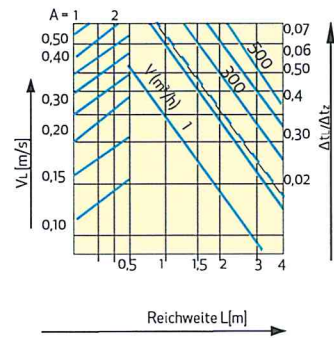

500x24 B>4m

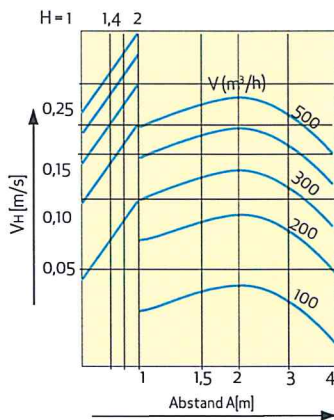

500x24 B<4m

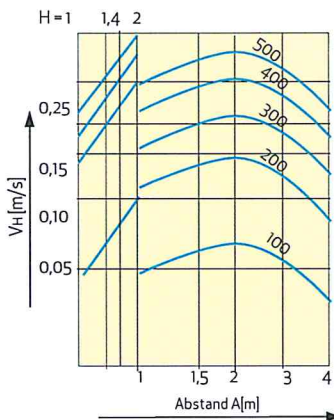

500x24

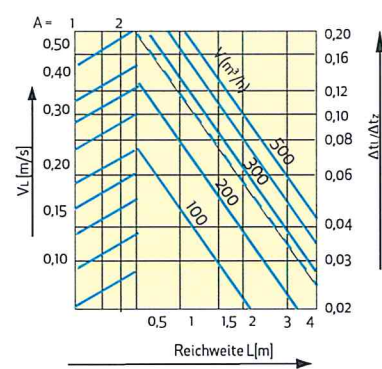

600x24, 625x24 B>4m

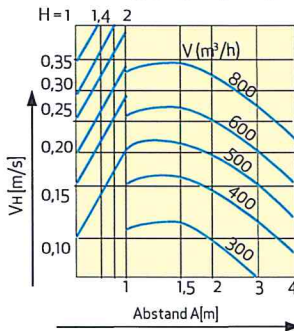

600x24, 625x24 B<4m

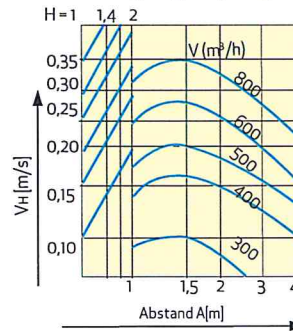

600x24, 625x24

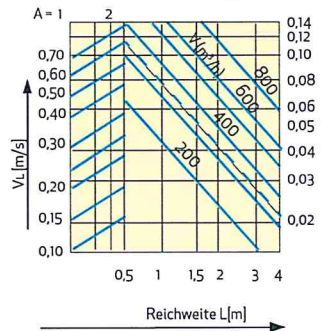

600x48 B>4m

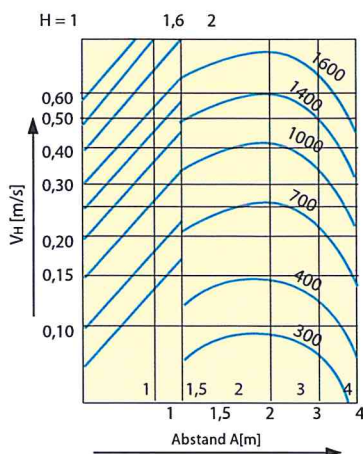

600x48 B<4m

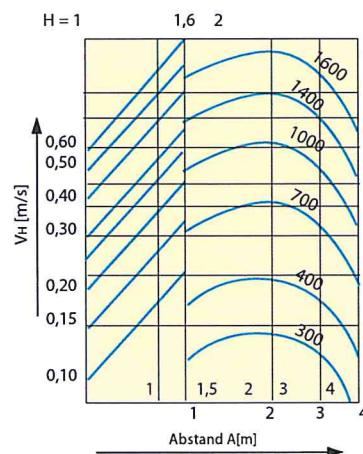

600x48

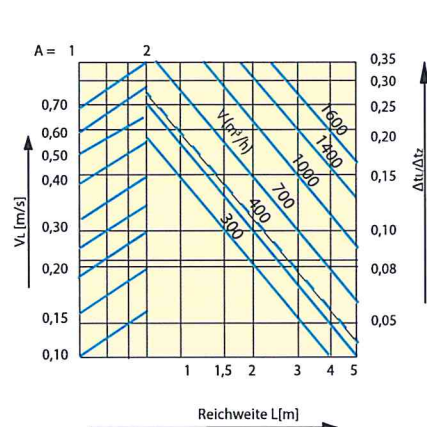

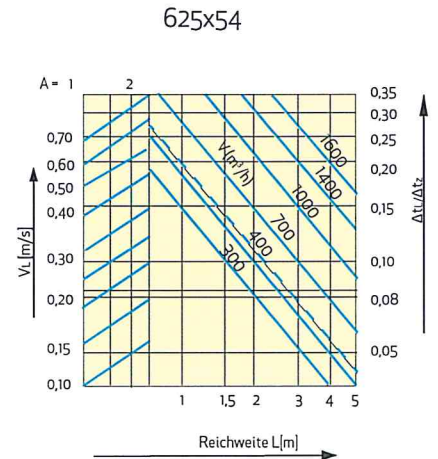
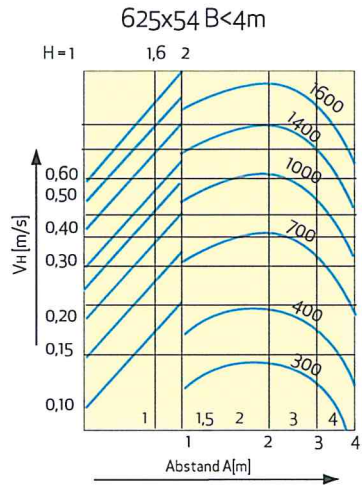
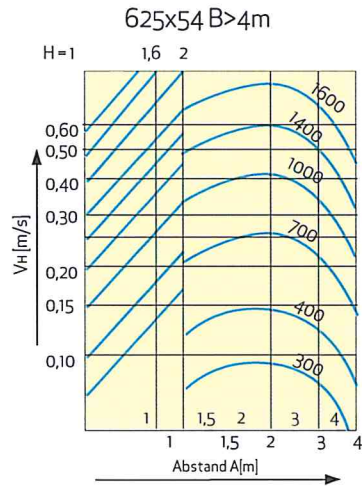

B. Druckverluste und Schalleistungspegel (Regelklappwinkel: 90° – geöffnet, 45° – halbgeöffnet)

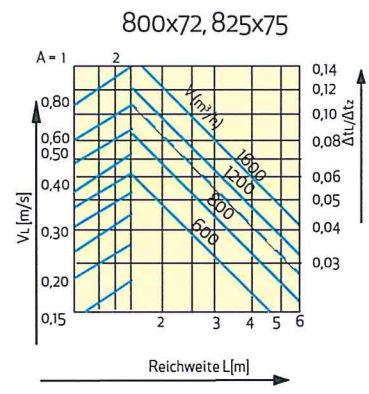
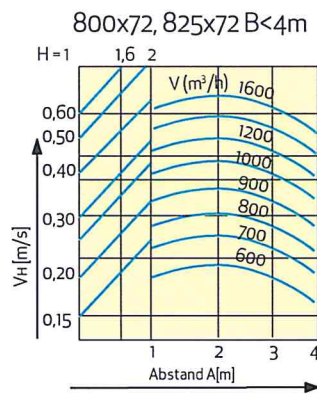
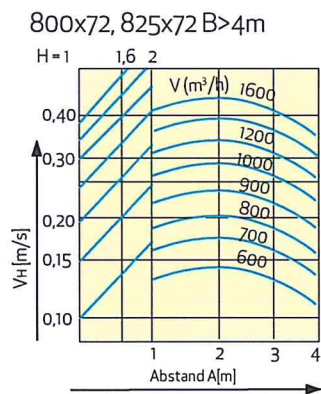

B. Pressure drop and sound power level depending on blade position of the plenum and on type of connection - vertical or horizontal. (90°- open, 45° - half closed)

